

## Beam Power Tube

CERAMIC-METAL SEALS  
 "ONE-PIECE" ELECTRODE DESIGN  
 FORCED-AIR COOLED

COAXIAL-ELECTRODE STRUCTURE  
 INTEGRAL RADIATOR  
 1250-WATTS CW INPUT UP TO 1215 Mc  
 MATRIX-TYPE, OXIDE-COATED, UNIPOTENTIAL CATHODE

For Use under Severe Shock and Vibration

## GENERAL DATA

## Electrical:

Heater, for Matrix-Type, Oxide-Coated,

Unipotential Cathode:

Voltage (AC or DC) <sup>a</sup> . . . . .	6.3 ± 10%	volts
Current at heater volts = 6.3 . . . . .	7.85	amp
Minimum heating time. . . . .	120	sec

Mu-Factor, Grid No.2 to Grid No.1

for plate volts = 225, grid-No.2

volts = 225, and plate ma. = 100. . . . . 13

Direct Interelectrode Capacitances:<sup>b</sup>

Grid No.1 to plate. . . . .	0.11 max.	μf
Grid No.1 to cathode & heater . . . . .	29	μf
Plate to cathode & heater . . . . .	0.011 max.	μf
Grid No.1 to grid No.2. . . . .	37	μf
Grid No.2 to plate. . . . .	5.3	μf
Grid No.2 to cathode & heater . . . . .	1.1 max.	μf

## Mechanical:

Operating Position. . . . .	Any
Overall Length. . . . .	2.34" ± 0.06"
Greatest Diameter (See <i>Dimensional Outline</i> ). . . . .	2.06" ± 0.03"
Weight (Approx.). . . . .	3/4 lb
Radiator. . . . .	Integral part of tube
Terminal Connections (See <i>Dimensional Outline</i> ):	

G<sub>1</sub> - Grid-No.1-

Terminal

Contact

Surface

G<sub>2</sub> - Grid-No.2-

Terminal

Contact

Surface

H - Heater-

Terminal

Contact

Surface

H, K - Heater- &

Cathode-

Terminal

Contact

Surface

P - Plate-

Terminal

Contact

Surface

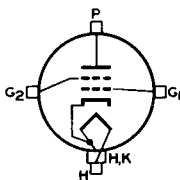

## Air Flow:

Air flow may be removed simultaneously with all voltages.

*Through radiator*—Adequate air flow to limit the plate-core temperature to 250° C should be delivered by a blower through the radiator during the application of plate, grid-No.2, and grid-No.1 voltages. Typical values

← Indicates a change.



of air flow directed through the radiator to maintain the plate core (See *Dimensional Outline*) at 250° C with an incoming air temperature of 25° C and with no restrictions at the plate-contact flange are:

Plate Dissipation (watts)	Air Flow (cubic ft/min)	Static Pressure (inches of water)
100	2	0.04
300	4	0.14
600	11	0.66
700	16	0.96

To grid-No.2, grid-No.1, cathode, and heater terminals—

A sufficient quantity of air should be directed at the heater terminal and allowed to flow past each of these terminals so that no terminal temperature exceeds the specified maximum value of 250° C. An air flow of 2.5 cfm is usually adequate. Forced-air cooling of heater and cathode terminals is usually required during stand-by (heater only) operation.

Plate-Core Temperature. . . . .	250 max. °C
Terminal Temperature (Plate, Grid No.2, Grid No.1, Cathode, and Heater) . . . . .	250 max. °C

## AF POWER AMPLIFIER & MODULATOR

### Maximum CCS<sup>c</sup> Ratings, Absolute-Maximum Values:

DC PLATE VOLTAGE. . . . .	3000 max.	volts
DC GRID-No.2 VOLTAGE. . . . .	1200 max.	volts
MAX.-SIGNAL DC PLATE CURRENT <sup>d</sup> . . . . .	500 max.	ma
MAX.-SIGNAL GRID-No.1 CURRENT <sup>d</sup> . . . . .	100 max.	ma
MAX.-SIGNAL PLATE INPUT <sup>d</sup> . . . . .	1500 max.	watts
MAX.-SIGNAL GRID-No.2 INPUT <sup>d</sup> . . . . .	25 max.	watts
PLATE DISSIPATION <sup>d</sup> . . . . .	600 max.	watts

### Typical CCS Push-Pull Operation:

*Values are for 2 tubes*

DC Plate Voltage. . . . .	2700	3000	volts
DC Grid-No.2 Voltage <sup>e</sup> . . . . .	450	450	volts
DC Grid-No.1 Voltage from fixed-bias source. . . . .	-40	-40	volts
Peak AF Grid-No.1-to-Grid-No.1 Voltage. . .	80	80	volts
Zero-Signal DC Plate Current. . . . .	200	200	ma
Max.-Signal DC Plate Current. . . . .	900	1000	ma
Zero-Signal DC Grid-No.2 Current. . . . .	0	0	ma
Max.-Signal DC Grid-No.2 Current. . . . .	6	5	ma
Effective Load Resistance (Plate to plate). . . . .	6000	6400	ohms
Max.-Signal Driving Power (Approx.) . . . .	0	0	watts
Max.-Signal Power Output (Approx.) . . . .	1400	1600	watts

### Maximum Circuit Values:

Grid-No.1-Circuit Resistance under any condition: With fixed bias . . . . .	15000 max.	ohms
With cathode bias . . . . .	Not recommended	



## LINEAR RF POWER AMPLIFIER

### Single-Sideband Suppressed-Carrier Service

Maximum CCS<sup>c</sup> Ratings, Absolute-Maximum Values:

	<i>Up to 1215 Mc</i>	
DC PLATE VOLTAGE. . . . .	2500 max.	volts
DC GRID-No.2 VOLTAGE. . . . .	1200 max.	volts
MAX.-SIGNAL DC PLATE CURRENT. . . . .	500 max.	ma
MAX.-SIGNAL DC GRID-No.1 CURRENT. . . . .	100 max.	ma
MAX.-SIGNAL PLATE INPUT . . . . .	1250 max.	watts
MAX.-SIGNAL GRID-No.2 INPUT . . . . .	25 max.	watts
PLATE DISSIPATION . . . . .	600 max.	watts

#### Typical CCS "Single-Tone"<sup>f</sup> Operation: ←

*In grid-drive circuit at 30 Mc*

DC Plate Voltage. . . . .	2250	2500	volts
DC Grid-No.2 Voltage <sup>c</sup> . . . . .	450	450	volts
DC Grid-No.1 Voltage <sup>c</sup> . . . . .	37	37	volts
Zero-Signal DC Plate Current. . . . .	160	160	ma
Zero-Signal DC Grid-No.2 Current. . . . .	0	0	ma
Effective RF Load Resistance. . . . .	2500	2700	ohms
Max.-Signal DC Plate Current. . . . .	450	500	ma
Max.-Signal DC Grid-No.2 Current. . . . .	4	4	ma
Max.-Signal DC Grid-No.1 Current <sup>g</sup> . . . . .	0.05	0.05	ma
Output-Circuit Efficiency (Approx.) . . . . .	90	90	%
Max.-Signal Driver Power Output <sup>h</sup> (Approx.) . . . . .	1	1	watt
Max.-Signal Useful Power Output (Approx.) . . . . .	580 <sup>j</sup>	680 <sup>j</sup>	watts

#### Typical CCS Operation with "Two-Tone Modulation"<sup>k</sup> ←

*In grid-drive circuit at 30 Mc*

DC Plate Voltage. . . . .	2250	2500	volts
DC Grid-No.2 Voltage <sup>c</sup> . . . . .	450	450	volts
DC Grid-No.1 Voltage <sup>c</sup> . . . . .	-37	-37	volts
Zero-Signal DC Plate Current. . . . .	160	160	ma
Effective RF Load Resistance. . . . .	2500	2700	ohms
DC Plate Current at peak of envelope. . . . .	450	500	ma
Average DC Plate Current. . . . .	315	350	ma
DC Grid-No.2 Current at peak of envelope . . . . .	3	4	ma
Average DC Grid-No.2 Current. . . . .	1.8	2.5	ma
Average DC Grid-No.1 Current. . . . .	0.005	0.05	ma
Peak-Envelope Driver Power (Approx.) . . . . .	1	1	watt
Output-Circuit Efficiency (Approx.) . . . . .	90	90	%
Distortion Products Level: <sup>l</sup>			
Third Order . . . . .	-31	-31	db
Fifth Order . . . . .	-36	-36	db
Useful Power Output (Approx.):			
Average . . . . .	290	340	watts
Peak Envelope . . . . .	580 <sup>j</sup>	680 <sup>j</sup>	watts

#### Maximum Circuit Values:

Grid-No.1-Circuit Resistance under any condition:

For fixed-bias operation. . . . .	15000 max.	ohms
For cathode-bias operation. . . . .	Not recommended	

← Indicates a change.



## PLATE-MODULATED RF POWER AMPLIFIER — Class C Telephony

Carrier conditions per tube for use  
with a maximum modulation factor of 1

### Maximum CCS<sup>c</sup> Ratings, Absolute-Maximum Values:

	<i>Up to 1215 Mc</i>	
DC PLATE VOLTAGE. . . . .	2000 max.	volts
DC GRID-No.2 VOLTAGE. . . . .	1200 max.	volts
DC GRID-No.1 VOLTAGE. . . . .	-250 max.	volts
DC PLATE CURRENT. . . . .	500 max.	ma
DC GRID-No.1 CURRENT. . . . .	100 max.	ma
PLATE INPUT . . . . .	1000 max.	watts
GRID-No.2 INPUT . . . . .	17 max.	watts
PLATE DISSIPATION . . . . .	400 max.	watts

### Typical CCS Operation:

*In cathode-drive<sup>m</sup> circuit at 400 Mc*

DC Plate Voltage. . . . .	1800	2000	volts
DC Grid-No.2 Voltage <sup>n</sup> . . . . .	400	400	volts
DC Grid-No.1 Voltage <sup>p</sup> . . . . .	-45	-35	volts
DC Plate Current. . . . .	450	500	ma
DC Grid-No.2 Current. . . . .	6	8	ma
DC Grid-No.1 Current (Approx.) . . . . .	15	12	ma
Output-Circuit Efficiency (Approx.) . . . . .	80	80	%
Driver Power Output (Approx.) <sup>q</sup> . . . . .	35	35	watts
Useful Power Output (Approx.) . . . . .	500 <sup>j</sup>	600 <sup>j</sup>	watts

### Maximum Circuit Values:

Grid-No.1-Circuit Resistance under any condition . . . . .	15000 max.	ohms
---	------------	------

## RF POWER AMPLIFIER & OSCILLATOR — Class C Telegraphy<sup>r</sup> and

## RF POWER AMPLIFIER — Class C FM Telephony

### Maximum CCS<sup>c</sup> Ratings, Absolute-Maximum Values:

	<i>Up to 1215 Mc</i>	
DC PLATE VOLTAGE. . . . .	2500 max.	volts
DC GRID-No.2 VOLTAGE. . . . .	1200 max.	volts
DC GRID-No.1 VOLTAGE. . . . .	-250 max.	volts
DC PLATE CURRENT. . . . .	500 max.	ma
DC GRID-No.1 CURRENT. . . . .	100 max.	ma
PLATE INPUT . . . . .	1250 max.	watts
GRID-No.2 INPUT . . . . .	25 max.	watts
PLATE DISSIPATION . . . . .	700 max.	watts

### Typical CCS Operation:

*In cathode-drive<sup>m</sup> circuit at 400 Mc*

DC Plate Voltage. . . . .	2250	2500	volts
DC Grid-No.2 Voltage <sup>n</sup> . . . . .	400	400	volts
DC Grid-No.1 Voltage. . . . .	-45	-35	volts
DC Plate Current. . . . .	450	500	ma
DC Grid-No.2 Current. . . . .	7	8	ma



DC Grid-No.1 Current (Approx.) . . . . .	10	12	ma
Output-Circuit Efficiency (Approx.) . . . . .	80	80	%
Driver Power Output (Approx.) <sup>g</sup> . . . . .	30	35	watts
Useful Power Output (Approx.) . . . . .	650 <sup>j</sup>	800 <sup>j</sup>	watts

*In cathode-drive<sup>n</sup> circuit at 1215 Mc*

DC Plate Voltage. . . . .	2500	volts
DC Grid-No.2 Voltage <sup>h</sup> . . . . .	400	volts
DC Grid-No.1 Voltage. . . . .	-50	volts
DC Plate Current. . . . .	500	ma
DC Grid-No.2 Current. . . . .	6	ma
DC Grid-No.1 Current (Approx.) . . . . .	10	ma
Output-Circuit Efficiency (Approx.) . . . . .	70	%
Driver Power Output (Approx.) <sup>g</sup> . . . . .	80	watts
Useful Power Output (Approx.) . . . . .	375 <sup>j</sup>	watts

**Maximum Circuit Values:**

Grid-No.1-Circuit Resistance under any condition:

- For fixed-bias operation. . . . . 15000 max. ohms  
 For cathode-bias operation. . . . . Not recommended

- <sup>a</sup> Because the cathode is subjected to considerable back bombardment as the frequency is increased with resultant increase in temperature, the heater voltage should be reduced depending on operating conditions and frequency to prevent overheating the cathode and resultant short life.
- <sup>b</sup> Measured with special shield adapter.
- <sup>c</sup> Continuous Commercial Service.
- <sup>d</sup> Averaged over any audio-frequency cycle of sine-wave form.
- <sup>e</sup> Preferably obtained from a fixed supply.
- <sup>f</sup> "Single-Tone" operation refers to that class of amplifier service in which the grid-No.1 input consists of a monofrequency rf signal having constant amplitude. This signal is produced in a single-sideband suppressed-carrier system when a single audio frequency of constant amplitude is applied to the input of the system.
- <sup>g</sup> This value represents the approximate grid-No.1 current obtained due to initial electron velocities and contact-potential effects when grid No.1 is driven to zero volts at maximum signal.
- <sup>h</sup> Driver power output represents circuit losses and is actual power measured at the input to grid-No.1 circuit used. The tube driving power is zero watts.
- <sup>j</sup> This value of useful power is measured in load of output circuit.
- <sup>k</sup> "Two-Tone-Modulation" operation refers to that class of amplifier service in which the input consists of two monofrequency rf signals having equal peak amplitude.
- <sup>l</sup> with maximum signal output used as a reference, and without the use of feedback to enhance linearity.
- <sup>m</sup> Cathode is at dc ground potential.
- <sup>n</sup> Obtained preferably from a separate source modulated along with the plate supply.
- <sup>p</sup> Obtained from grid-No.1 resistor or from a combination of grid-No.1 resistor with either fixed supply or cathode resistor.
- <sup>q</sup> Driver power output includes circuit losses and feed-through power. It is the actual power measured at input to drive circuit.
- <sup>r</sup> Key-down conditions per tube without amplitude modulation. Amplitude modulation essentially negative may be used if the positive peak of the audio-frequency envelope does not exceed 115 per cent of the carrier conditions.
- <sup>s</sup> Obtained preferably from a fixed supply, or from the plate supply voltage with a voltage divider.



→ CHARACTERISTICS RANGE VALUES FOR EQUIPMENT DESIGN

	Note	Min.	Max.	
Heater Current. . . . .	1	7.4	8.3	amp
Direct Interelectrode Capacitances:				
Grid No.1 to plate. . . . .	2	-	0.11	$\mu\text{f}$
Grid No.1 to cathode & heater . . . . .	2	26	32	$\mu\text{f}$
Plate to cathode & heater . . . . .	2	-	0.011	$\mu\text{f}$
Grid No.1 to grid No.2. . . . .	2	34	41	$\mu\text{f}$
Grid No.2 to plate. . . . .	2	4.3	6.3	$\mu\text{f}$
Grid No.2 to cathode & heater . . . . .	2	-	1.1	$\mu\text{f}$
Reverse Grid-No.1 Current . . . . .	1,3	-	-50	$\mu\text{a}$
Peak Emission Current . . . . .	1,4	80	-	amp
Interelectrode Leakage Resistance . . . . .	5	8	-	megohms
Grid-No.1 Cutoff Voltage. . . . .	1,6	-	-87	volts

Note 1: With 6.3 volts ac or dc on heater.

Note 2: Measured with special shield adapter.

Note 3: With dc plate voltage of 2500 volts, dc grid-No.2 voltage of 400 volts, and dc grid-No.1 voltage adjusted to give a dc plate current of 240 ma.

Note 4: For conditions with 6.3 volts on heater; grid No.1, grid No.2 and plate tied together; and pulse-voltage source of 850 peak volts connected between plate and cathode. Pulse duration is 2 microseconds, pulse-repetition frequency is 60 pps, and duty factor is 0.00012. Read peak emission current after 1 minute.

Note 5: Under conditions with tube at 20° to 30° C for at least 30 minutes without any voltages applied to the tube. The minimum resistance between any two electrodes as measured with a 200-volt Megger-type ohmmeter having an internal impedance of 1 megohm, will be 8 megohms.

Note 6: With dc plate voltage of 2500 volts, dc grid-No.2 voltage of 400 volts, and dc grid-No.1 voltage adjusted to give a dc plate current of 5 ma.

### SPECIAL TESTS & PERFORMANCE DATA

Resonances in the tube mountings used in the following tests can cause the specified environmental conditions to produce greatly amplified effects. Extreme care must, therefore, be used in the design of the mountings to minimize resonances. Design details of mountings used by the RCA Electron Tube Division to perform these tests may be obtained from RCA Commercial Engineering, Harrison, N.J., on request.

#### 50-g, 11-Millisecond Shock Test:

This test is performed on sample lots of tubes to determine the ability of the tube to withstand the specified long-duration impact acceleration. Tubes are held rigid in six different positions in a Medium-Impact Shock Machine and are subjected to three blows in each position. At the end of this test, tubes will not show permanent or temporary shorts or open circuits.

#### 500-g, Nominal 3/4-Millisecond Shock Test:

This test is performed on sample lots of tubes to determine the ability of the tube to withstand the specified impact acceleration. Tubes are held rigid in four different

→ Indicates a change.



positions in a High-Impact Shock Machine and are subjected to five blows in each position. At the end of this test, tubes will not show permanent or temporary shorts or open circuits.

#### 5-to-2000 cps Vibration Test:

This test is performed on sample lots of tubes to determine the ability of the tube to withstand variable-frequency vibration. With heater voltage of 6.3 volts ac or dc, dc plate supply voltage of 300 volts, dc grid-No.2 voltage adjusted to give dc plate current of 10 ma., and plate load resistor of 2000 ohms, the tube is vibrated along each of three mutually perpendicular axes over an 8-minute cycle consisting of:

- a. 5-to-10 cps with fixed double amplitude of 0.080 inch  $\pm$  10%.
- b. 10-to-15 cps at fixed acceleration of 0.41 g  $\pm$  10%.
- c. 15-to-105 cps with fixed double amplitude of 0.036 inch  $\pm$  10%.
- d. 105-to-2000 cps at fixed acceleration of 20 g  $\pm$  10%.

At the end of this test, tubes will not show permanent or temporary shorts or open circuits.

#### OPERATING CONSIDERATIONS

A suggested *mounting arrangement* for the 7650 is shown in the accompanying drawing along with a layout of the associated contacts. Flexible connectors are required for the plate, grid-No.2, grid-No.1, cathode, and heater contact surfaces.

*The maximum-rated plate and grid-No.2 voltages of this tube are extremely dangerous.* Great care should be taken during the adjustment of circuits. The tube and its associated apparatus, especially all parts which may be at high potential above ground, should be housed in a protective enclosure. The protective housing should be designed with interlocks so that personnel can not possibly come in contact with any high-potential point in the electrical system. The interlock devices should function to break the primary circuit of the high-voltage supplies when any gate or door on the protective housing is opened, and should prevent the closing of the primary circuit until the door is again locked.



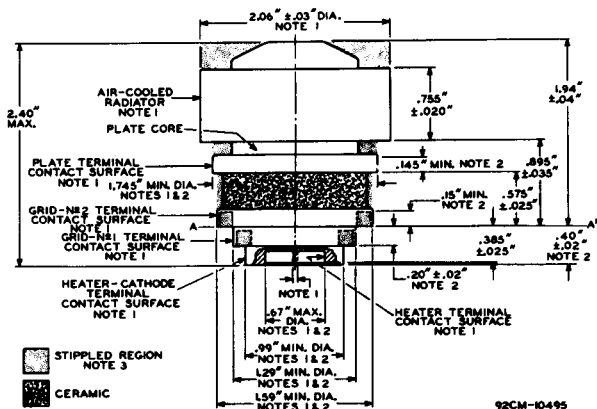

**NOTE 1:** WITH THE CYLINDRICAL SURFACES OF THE RADIATOR BAND, PLATE TERMINAL, GRID-NO.2 TERMINAL, GRID-NO.1 TERMINAL, HEATER-CATHODE TERMINAL, AND HEATER TERMINAL CLEAN, SMOOTH, AND FREE OF BURRS, THE TUBE WILL ENTER A GAUGE AS SHOWN IN SKETCH G<sub>1</sub>. PROPER ENTRY OF THE TUBE IS OBTAINED WHEN THE GRID-NO.2 TERMINAL IS SEATED ON THE SHOULDER WHEN A 0.010" THICKNESS GAUGE 1/8" WIDE WILL NOT ENTER MORE THAN 1/16" BETWEEN THE SHOULDER SURFACE AND THE GRID-NO.2 TERMINAL. THE GAUGE IS PROVIDED WITH SLOTS TO PERMIT MAKING MEASUREMENT OF SEATING OF GRID-NO.2 TERMINAL ON SHOULDER A-A'.

**NOTE 2:** THE DIAMETER OF EACH TERMINAL IS HELD TO INDICATED VALUES ONLY OVER THE INDICATED MINIMUM LENGTH OF ITS CONTACT SURFACE.

**NOTE 3:** KEEP ALL STIPPLED REGIONS CLEAR. DO NOT ALLOW CONTACTS OR CIRCUIT COMPONENTS TO PROTRUDE INTO THESE ANNULAR VOLUMES. DIAMETERS OF STIPPLED AREAS ABOVE AIR-COOLED RADIATOR, PLATE-TERMINAL CONTACT SURFACE, AND GRID-NO.2-TERMINAL CONTACT SURFACE SHALL NOT BE GREATER THAN ITS ASSOCIATED DIAMETER.





## SUGGESTED MOUNTING ARRANGEMENT & LAYOUT OF ASSOCIATED CONTACTS

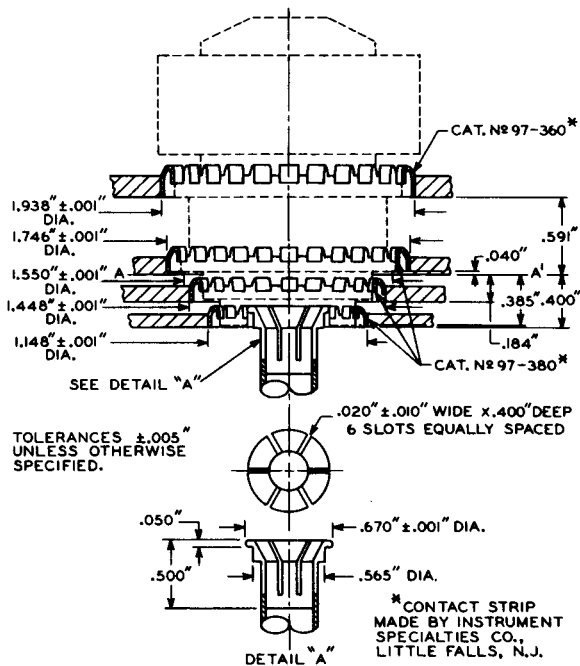

92CM-10503

## TYPICAL PLATE CHARACTERISTICS

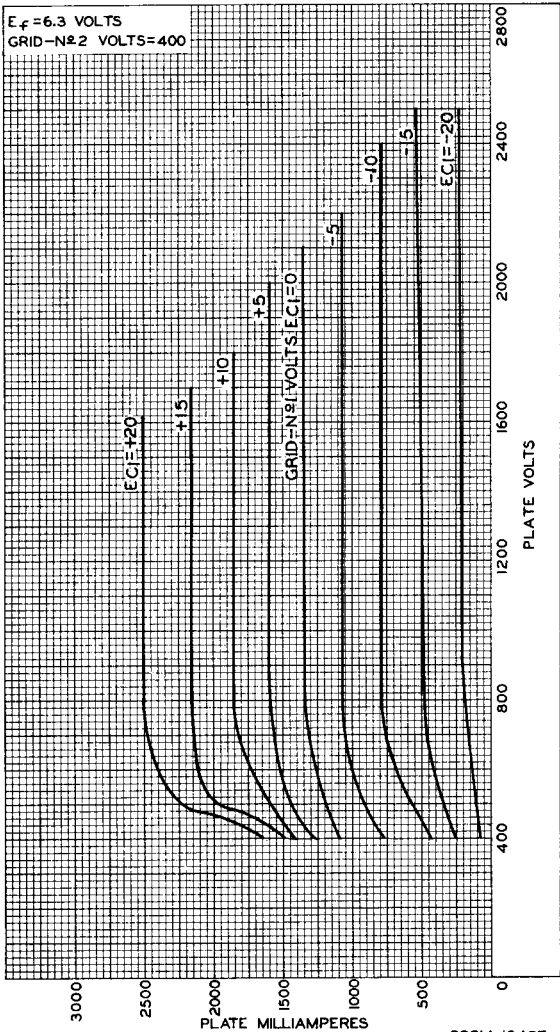

92CM-10487



## TYPICAL CHARACTERISTICS

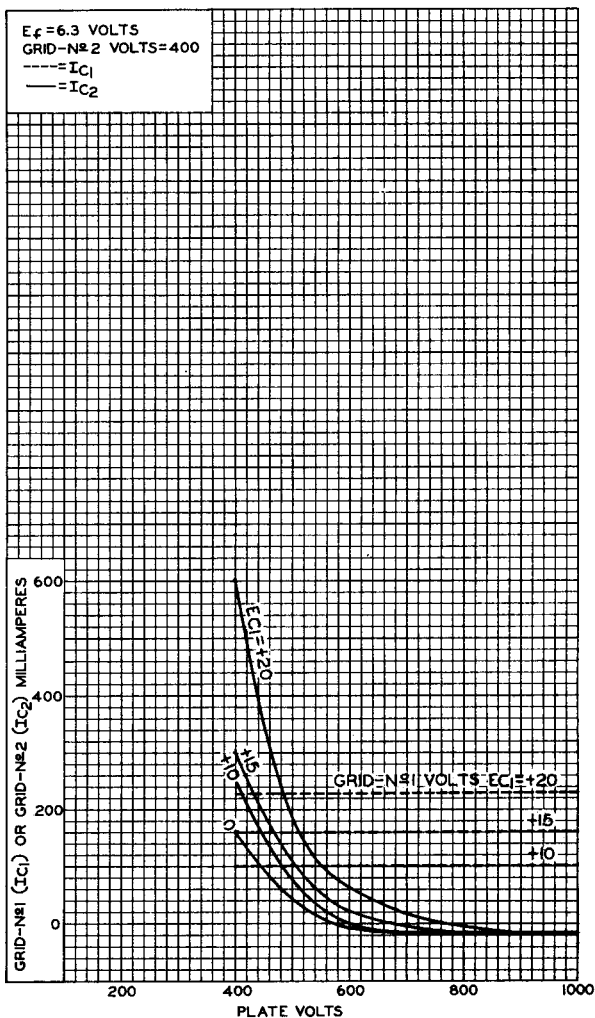

92CM-10488



## TYPICAL CONSTANT-CURRENT CHARACTERISTICS

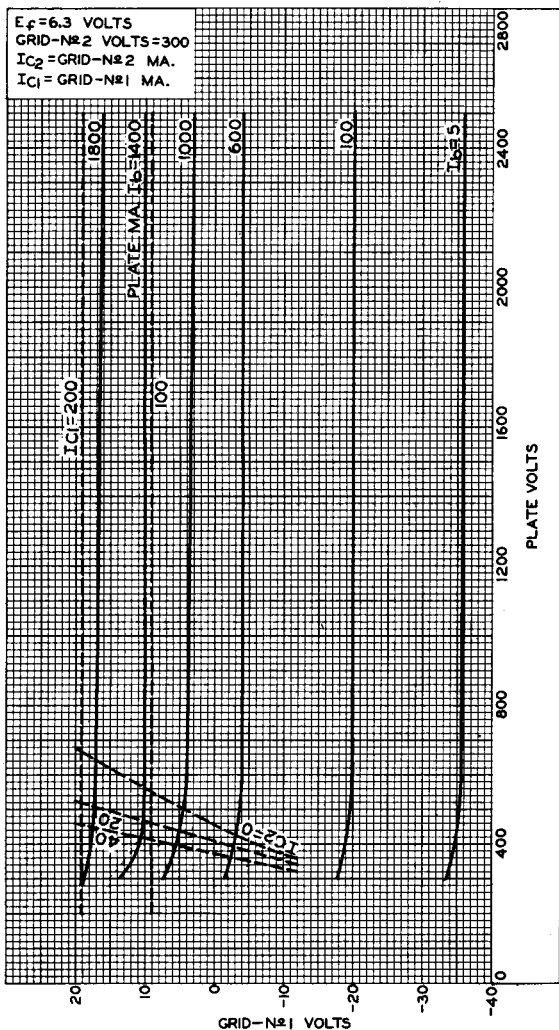

92CM-10493RI



## TYPICAL CONSTANT-CURRENT CHARACTERISTICS

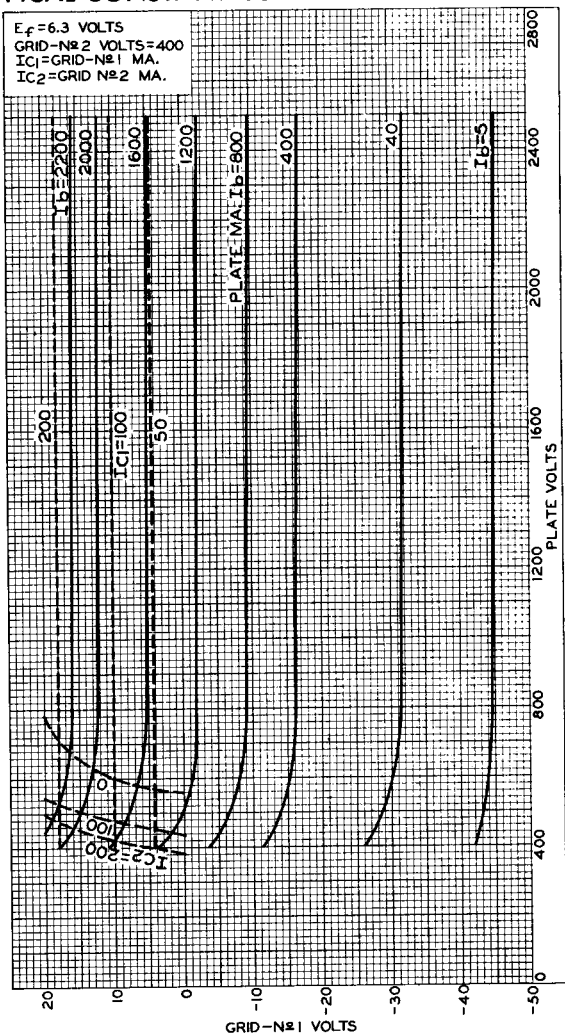

92CM-10494

